

Data Sheet



Article number: 201118280

Description: E+G Handwheel
GN 323-100-B10-R

Measures

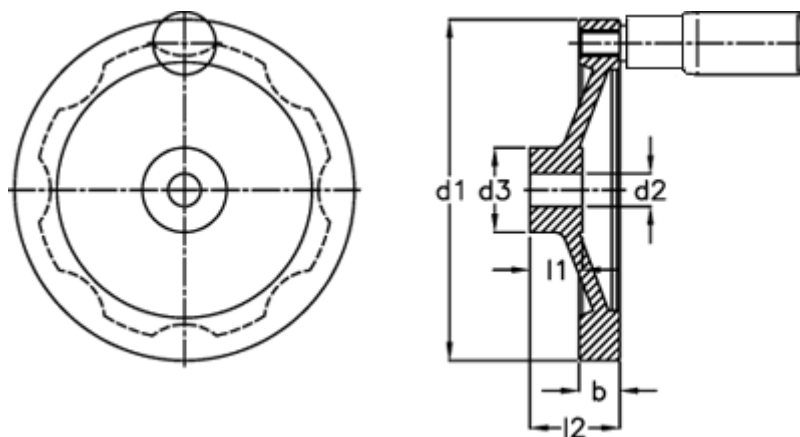

b	= 14.0
d1	= 100
d2 H7	= 10
d3	= 28
Handle	= 18
l1	= 17
l2	= 30